

LOW PRESSURE TRANSDUCER

For Additional Information See PR-274/275 Data Sheet

SPECIFICATIONS

Accuracy*: ±1% FS

Overpressure: 10 PSID

Supply Voltage: 12-40 VDC
 12-35 VAC (VDC output units only)

Supply Current: VDC Units - 10 mA max.
 mA Units - 20 mA max.

Enclosure: 18 Ga C. R. Steel NEMA 4 (IP-65) or Panel Mount Chassis

Finish: Baked on enamel-PMS2GR88B

Compensated Temp Range: 25°F-150°F (-4°C-65°C)

T. C. Error: ±0.0125%/°F (.02%/°C)

Operating Temp Range: 0°F-175°F (-18°C-80°C)

Media Compatibility: Clean dry air or any inert gas

Environmental: 10-90%RH Non-Condensing

Termination: Unpluggable screw terminal block

Wire Size: 12 Ga max.

Load Impedance: 1.6K ohms max. at 40 VDC (mA output units)
 1K ohms min. (VDC output units)

Weight: Enclosure - 1.0 lbs. (.45 kg)
 Panel Mount - 0.5 lbs. (.25 kg)

*Includes non-linearity, hysteresis and non-repeatability

ORDERING INFORMATION

PACKAGING	RANGE	OUTPUT
274 (enclosure)	R1 0 TO 0.10 / -0.05 TO +0.05 ("wc)	mA (4-20 mA 2-wire)
275 (panel mount)	R2 0 TO 1.0 / 0 TO 0.5 / 0 TO 0.25 / -0.5 TO +0.5 / -0.25 TO +0.25 / -0.125 TO +0.125 ("wc)	VDC (0-5 VDC or 0-10 VDC field selectable)
	R3 0 TO 5.0 / 0 TO 2.5 / 0 TO 1.25 / -2.5 TO +2.5 / -1.25 TO +1.25 / -0.625 TO +0.625 ("wc)	
	R4 0 TO 30 / 0 TO 15 / 0 TO 7.5 / -15.0 TO +15.0 / -7.5 TO +7.5 / -3.75 TO +3.75 ("wc)	
	R5 0 TO 25 / -12.5 TO +12.5 (pa)	
	R6 0 TO 250 / 0 TO 125 / 0 TO 62.5 / -125 TO +125 / -62.5 TO +62.5 / -31.25 TO +31.25 (pa)	
	R7 0 TO 1250 / 0 TO 625 / 0 TO 312.5 / -625 TO +625 / -312.5 TO +312.5 / -156.25 TO +156.25 (pa)	
	R8 0 TO 7500 / 0 TO 3750 / 0 TO 1875 / -3750 TO +3750 / -1875 TO +1875 / -937.5 TO +937.5 (pa)	

INSTALLATION

Inspection - Inspect the package for damage. If damaged, notify the appropriate carrier immediately. If undamaged, open the package and inspect the device for obvious damage. Return damaged products.

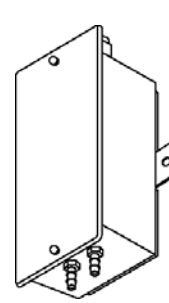

Enclosure Mount Transducer

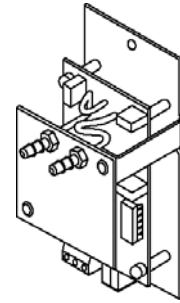

Panel Mount Transducer

- Requirements**
- Tools (not provided)
 - Digital Volt-ohm Meter (DVM)
 - Appropriate screwdriver for mounting screws
 - Appropriate drill and drill bit for mounting screws
 - Appropriate accessories
 - Two #8 self-tapping mounting screws (*not provided*)
 - Training: **Installer must be a qualified, experienced technician**



Warning:

- Disconnect power supply before installation to prevent electrical shock and equipment damage.
- Make all connections in accordance with the job wiring diagram and in accordance with national and local electrical codes. Use copper conductors only.



Caution:

- Use electrostatic discharge precautions (e.g., use of wrist straps) during installation and wiring to prevent equipment damage.
- Avoid locations where severe shock or vibration, excessive moisture or corrosive fumes are present. NEMA Type 4 housings are intended for outdoor use primarily to provide a degree of protection against wind-blown dust, rain, and hose-directed water.
- Do not exceed ratings of the device.



Caution:

- Condensate or moisture must not enter pressure sensor ports

Mounting

The PR-274/275 must be mounted as indicated by the arrows on the enclosure. Refer to **Figure 7** for mounting dimensions.

1. Remove the transducer cover using a Phillips head screwdriver.
2. Select the mounting location.
3. Mount transducer on a vertical surface with two #8 self-tapping screws (not provided).
4. Transducer must be mounted above the pressure pick-up or a J-Loop must be incorporated in the tubing to function as a condensate trap.
5. Pull wires through bottom of enclosure and make necessary connections.
6. Replace cover and make pneumatic connections.

Wiring

Use maximum 12 AWG wire for wiring terminals. Use flexible 1/4" O.D. 5/32" I.D. tubing for the high and low pressure connections. Refer to **Figures 1, 2, 3, & 4** for wiring information and **Figures 5 & 6** for switch designations.

(Wiring Instructions continued on pages 2 and 3.)



LOW PRESSURE TRANSDUCER

Wiring PR-274/275 Units with mA Output

PR-274/275 Low Pressure Transducer with mA Output

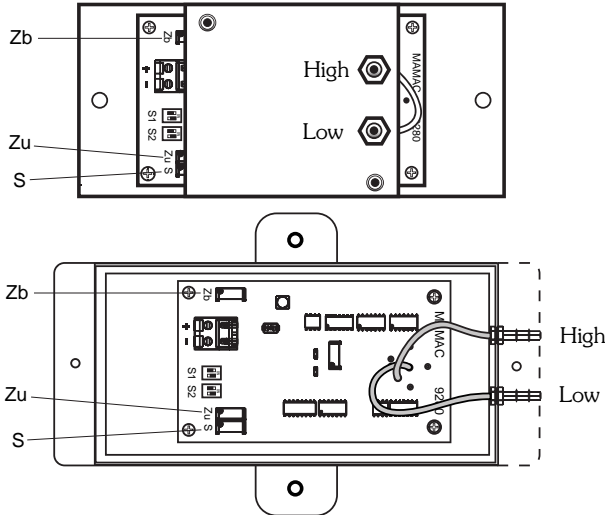

PR-274/275 pressure transducers with 4-20 mA output are powered with a 12-40 VDC supply.

The following describes the proper wiring of these pressure transducers with mA output:

1. Remove the terminal block by carefully pulling it off the circuit board.
2. Locate the [+] and [-] terminal markings on the board.
3. Attach the supply voltage to the [+] lead.
4. Connect the 4-20 mA output ([-] terminal) to the controller's input terminal.
5. Ensure that the power supply common is attached to the common bus of the controller.
6. Re-insert the terminal block to the circuit board and apply power to the unit.
7. Check for the appropriate output signal using a DVM set on DC milliamps connected in series with the [-] terminal.

Wiring PR-274/275 Units with VDC Output

PR-274/275 Low Pressure Transducer with VDC Output

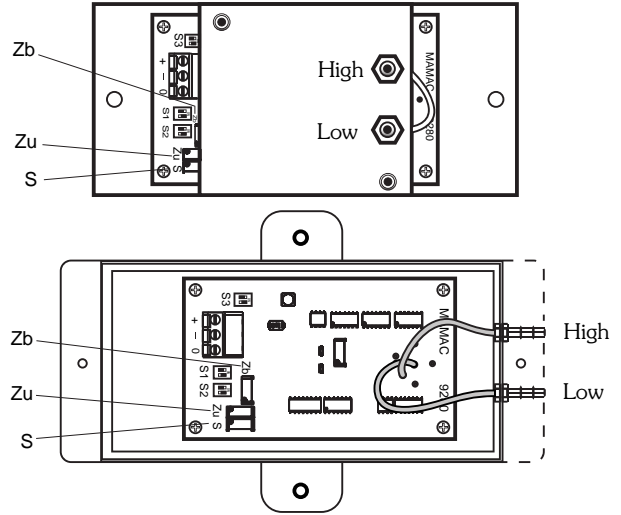

PR-274/275 pressure transducers with VDC output are field selectable 0-5 VDC or 0-10 VDC output and can be powered with either a 12-40 VDC or 12-35 VAC.

The following describes the proper wiring of these pressure transducers with VDC output:

1. Remove the terminal block by carefully pulling it off the circuit board.
2. Locate the [+], [-] and [O] terminal markings on the board.
3. Attach the power wires to the [+] and [-] terminals. The [-] terminal is also the negative terminal.
4. Connect the [O] terminal, which is the positive VDC output terminal, to the controller's input terminal.
5. Re-insert the terminal block to the circuit board and apply power to the unit.
6. Check the appropriate VDC output using a voltmeter set on DC volts across the [O] and [-] terminals.

TYPICAL APPLICATIONS (wiring diagrams)

Figure 1 and Figure 2 illustrate typical wiring diagrams for the mA output low pressure transducer.

Figure 1 - Wiring for mA Low Pressure Transducers with an External DC Power Supply

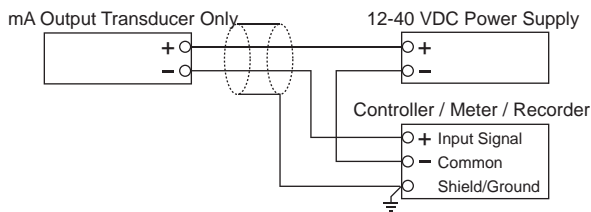
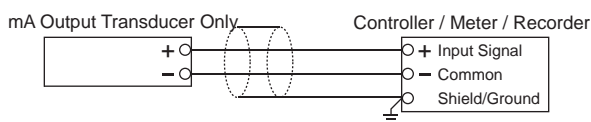

Figure 2 - Wiring for mA Output Transducers where the Controller or Meter has an Internal DC Power Supply



TYPICAL APPLICATIONS (wiring diagrams)

Figure 3 and Figure 4 illustrate typical wiring diagrams for the VDC output low pressure transducer.

Figure 3 - Wiring for VDC Low Pressure Transducers When Applied with External AC Supply

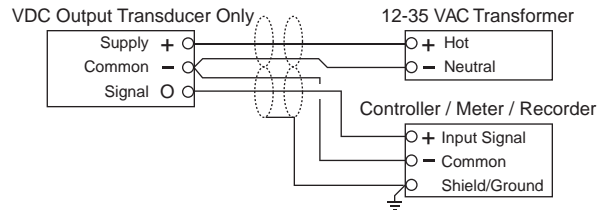
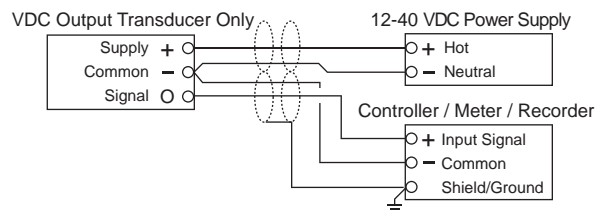

Figure 4 - Wiring for VDC Low Pressure Transducers When Applied with External DC Supply





LOW PRESSURE TRANSDUCER

Figure 5 - Switch Selections for Low Pressure Transducers with mA Outputs

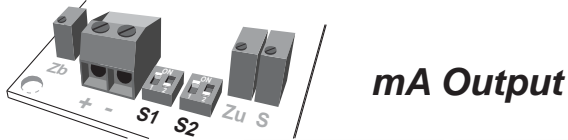

Range Configuration: Uni-Directional Switch 1 (S1)

R1/R5	0 - 0.10 "wc / 25 pa	Factory Sealed
R2/R6	0 - 1.0 "wc / 250 pa (default)	
	0 - 0.5 "wc / 125 pa	
	0 - 0.25 "wc / 62.5 pa	
R3/R7	0 - 5.0 "wc / 1250 pa (default)	
	0 - 2.5 "wc / 625 pa	
	0 - 1.25 "wc / 312.5 pa	
R4/R8	0 - 30.0 "wc / 7500 pa (default)	
	0 - 15.0 "wc / 3750 pa	
	0 - 7.5 "wc / 1875 pa	

Range Configuration: Bi-Directional Switch 1 (S1)

R1/R5	+/- 0.05 "wc / 12.5 pa	Factory Sealed
R2/R6	+/- 0.5 "wc / 125 pa (default)	
	+/- 0.25 "wc / 62.5 pa	
	+/- 0.125 "wc / 31.25 pa	
R3/R7	+/- 2.5 "wc / 625 pa (default)	
	+/- 1.25 "wc / 312.5 pa	
	+/- .625 "wc / 156.25 pa	
R4/R8	+/- 15.0 "wc / 3750 pa (default)	
	+/- 7.5 "wc / 1875 pa	
	+/- 3.75 "wc / 937.5 pa	

Output Configuration: Switch 2 (S2)

Uni-directional (default)	
Bi-directional	

Figure 6 - Switch Selections for Low Pressure Transducers with VDC Outputs

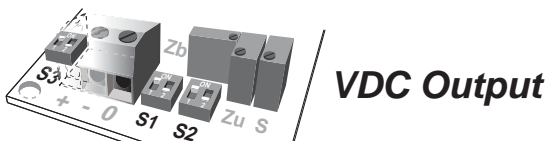

Range Configuration: Uni-Directional Switch 1 (S1)

R1/R5	0 - 0.10 "wc / 25 pa	Factory Sealed
R2/R6	0 - 1.0 "wc / 250 pa (default)	
	0 - 0.5 "wc / 125 pa	
	0 - 0.25 "wc / 62.5 pa	
R3/R7	0 - 5.0 "wc / 1250 pa (default)	
	0 - 2.5 "wc / 625 pa	
	0 - 1.25 "wc / 312.5 pa	
R4/R8	0 - 30.0 "wc / 7500 pa (default)	
	0 - 15.0 "wc / 3750 pa	
	0 - 7.5 "wc / 1875 pa	

Range Configuration: Bi-Directional Switch 1 (S1)

R1/R5	+/- 0.05 "wc / 12.5 pa	Factory Sealed
R2/R6	+/- 0.5 "wc / 125 pa (default)	
	+/- 0.25 "wc / 62.5 pa	
	+/- 0.125 "wc / 31.25 pa	
R3/R7	+/- 2.5 "wc / 625 pa (default)	
	+/- 1.25 "wc / 312.5 pa	
	+/- .625 "wc / 156.25 pa	
R4/R8	+/- 15.0 "wc / 3750 pa (default)	
	+/- 7.5 "wc / 1875 pa	
	+/- 3.75 "wc / 937.5 pa	

Output Configuration: Switch 2 (S2)

Uni-directional (default)	
Bi-directional	

Output Configuration: Switch 3 (S3)

0 - 10 (default)	
0 - 5 VDC	



LOW PRESSURE TRANSDUCER

- CHECKOUT**
1. Verify that the unit is mounted in the correct position.
 2. Verify appropriate input signal and supply voltage.

⚠ Caution: Never connect 120 VAC to these transducers. Never connect AC voltage to a unit intended for DC supply.

3. Verify appropriate configuration range.

Transducer Operation This is a rough functional check only.

1. Adjust the pressure to obtain maximum output signal for appropriate range.
2. Output should be 20 mA or 5 or 10 VDC.
3. Adjust the pressure to obtain minimum output signal.
4. Output should be 4 mA or 0 VDC.

NOTE: The PR-274/275 is a highly accurate device. For applications requiring a high degree of accuracy, the use of laboratory quality meters and gauges are recommended.

CALIBRATION All units are factory calibrated to meet or exceed published specifications. If field adjustment is necessary, follow the instructions below.

Calibration of PR-274/275 mA Units

1. Connect terminals [+] and [-] to the appropriate power source.
2. Connect the DVM in series on the [-] terminal.
3. Apply low pressure to the unit. If configured for uni-direction, adjust Zu trimmer to achieve desired low output. If configured for bi-direction, adjust Zb trimmer to achieve desired low output.
4. Apply high pressure to the unit and adjust span trimmer [S] to obtain the desired high output pressure.
5. Repeat steps 3 and 4 until desired calibration is achieved.

Calibration of PR-274/275 VDC Units

1. Connect terminals [+] and [-] to the appropriate power source. The [-] terminal is also the negative output terminal.
2. Connect the DVM on DC volts across [O] and [-] terminal.
3. Apply low pressure to the unit. If configured for uni-direction, adjust Zu trimmer to achieve desired low output. If configured for bi-direction, adjust Zb trimmer to achieve desired low output.
4. Apply high pressure to the unit and adjust span trimmer [S] to obtain the desired high output pressure.
5. Repeat steps 3 and 4 until desired calibration is achieved.

MAINTENANCE Regular maintenance of the total system is recommended to assure sustained optimum performance.

FIELD REPAIR None. Replace with a functional unit.

WARRANTY See Data Sheet for additional information.

Figure 7 - PR-274/275 Low Pressure Transducer Dimensions shown in inches and millimeters (mm).

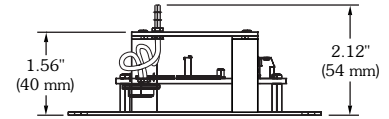

Panel Mount

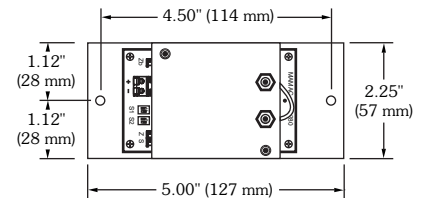

Enclosure

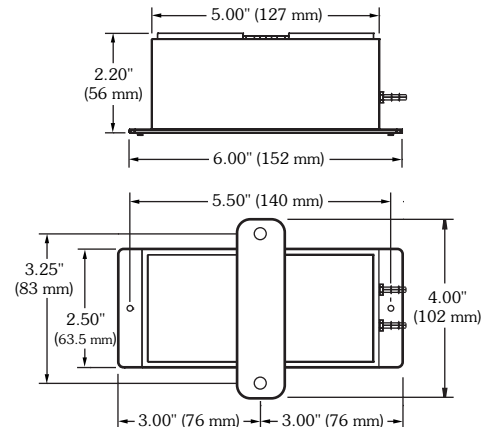

For Technical / Application Assistance call your nearest office



8189 Century Boulevard • Minneapolis, MN 55317-8002 • USA
800-843-5116 • 952-556-4900 • Fax 952-556-4997
sales@mamacsys.com • www.mamacsys.com

EUROPE

4200 Waterside Centre
 Solihull Parkway
 Birmingham • West Midlands
 B37 7YN • United Kingdom
 01384-271113 • Fax 01384-271114

CANADA

675 Cochrane Drive
 East Tower • 6th Floor
 Toronto • Ontario
 L3R 0B8 • Canada
 905-474-9215 • Fax 905-474-0876

ASIA

1 Fullerton Road #02-01
 One Fullerton
 Singapore • 049213
 65-31581826 • Fax 65-31581826

AUSTRALIA

4 Armiger Court, Unit 2
 Adelaide • S.A.
 5088 • Australia
 08-8395-4333 • Fax 08-8395-4433

MAMAC Systems, Inc., reserves the right to change any specifications without notice to improve performance, reliability, or function of our products.